

QoS and Packet Scheduling

Corso di Tecnologie di Infrastrutture di Reti

Carlo Augusto Grazia

Tenure-Track Assistant Professor (RTD-B)

Department of Engineering *Enzo Ferrari*
University of Modena and Reggio Emilia



Modena, 21st April 2026

- Quality of Service
 - What is it?
 - Why is it important?
- QoS Vs TCP/IP stack
 - Different layer → different QoS def.
- QoS in IP networks
 - Buffers
 - Packet Scheduling
 - Active Queue Management





Quality of Service: What is it?

QoS: Defined by the ITU in 1994

is the overall performance of a telephony or computer network



Quantitative measured in:

- error rates
- bandwidth
- throughput
- transmission delay
- jitter
- fairness
- ...

Quality of Service: Why is it important?

QoS

is particularly important for the transport of traffic with special requirements. (e.g VoIP, VIP, streaming, FTP)

Different applications means different requirements → different QoS

Application	loss	bandwidth	time-sensitive
File transfer	no loss	elastic	no
e-mail	no loss	elastic	no
Web browsing	no loss	elastic (few kbps)	no
VoIP	loss-tolerant	[few kbps, 1 Mbps] ¹	100s msec
VIP	loss-tolerant	[10 kbps, 5 Mbps] ¹	100s msec
Stored audio/video	loss-tolerant	like VoIP and VIP ¹	few seconds
Gaming	loss-tolerant	[few kbps, 10 kbps]	100s msec
Chat	no loss	elastic	depends

¹VoIP and VIP have also hard jitter constraint. Why stored audio/video not??

QoS vs TCP/IP

What's your QoS performance metric?

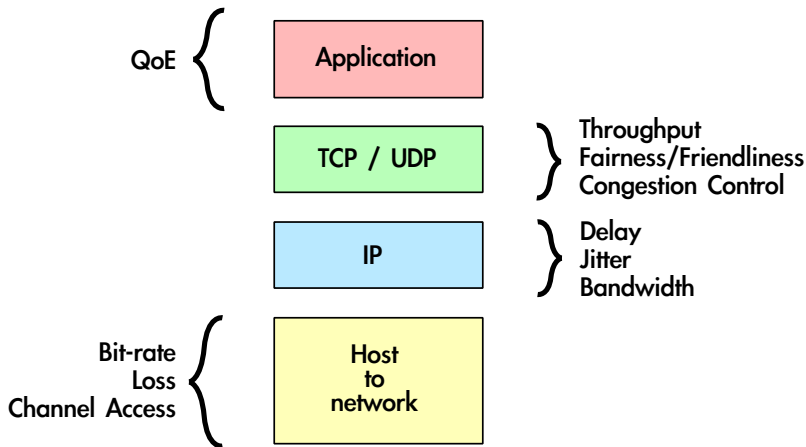

QoS vs TCP/IP

What's your QoS tech?

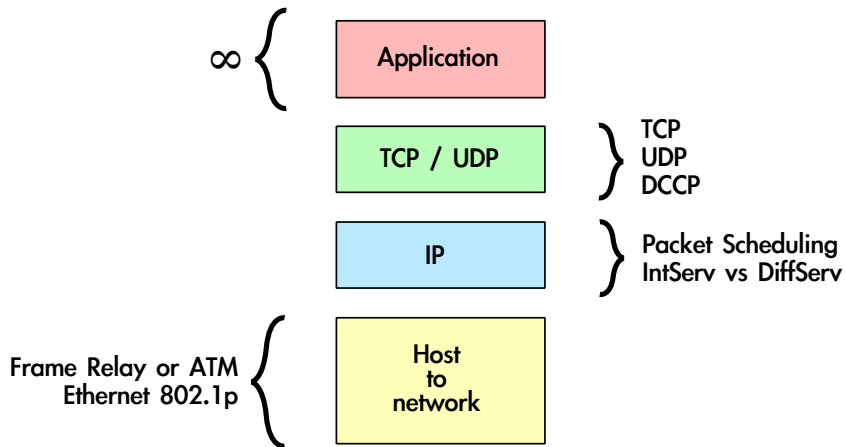

QoS at Layer 1

QoS is “hidden” at link layer:

- Loss
 - channel/modulation quality
 - CRC
- Delay
 - Tx delay
 - channel bandwidth
- Time varying link
 - adaptive modulation
 - models for channel estimation

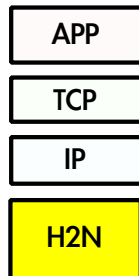

QoS at Layer 2

QoS has been born for layer 2:

- Frame Relay
- ATM
- 802.x family

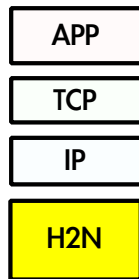



3-bit field called the Priority Code Point (PCP) within an Ethernet frame header:

PCP	Priority	Traffic Type
1	0 (lowest)	Background
0	1	Best Effort
2	2	Excellent Effort
3	3	Critical Applications
4	4	Video, <100 ms latency and jitter
5	5	Voice, <10 ms latency and jitter
6	6	Internetwork Control
7	7 (highest)	Network Control

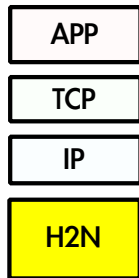

QoS at Layer 3

Encapsulate Layer 2 QoS in Layer 3 is not enough.

Module involved:

- Packet scheduler
- Routing protocol

The main choice is between:

- IntServ
- DiffServ

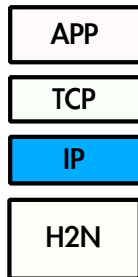

QoS at Layer 3: IntServ protocol

Fine-grained QoS system based on RSVP:

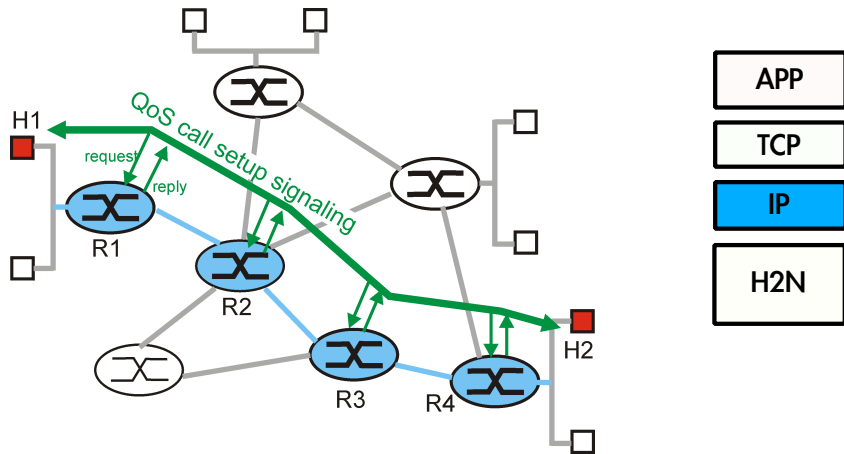

QoS at Layer 3: IntServ protocol

fine-grained QoS system based on RSVP:

- Pros
 - audio/video flow without interruption
 - easy guarantees definition
- Cons
 - all routers along the path must support it
 - no scalable
 - stateful
 - advances setup required
 - impractical for large networks (e.g. internet)
 - efficiency

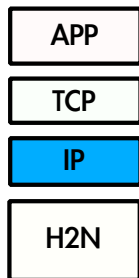

Still important and feasible for data-center or autonomous networks (e.g. bank or intranet)

QoS at Layer 3: DiffServ protocol

coarse-grained QoS system based on per-hop behavior and traffic classification:

- Pros
 - low latency for audio/video
 - best effort for non-critical services
 - no advanced setup requirement
- Cons
 - different routers could have different QoS behavior
 - end2end perf $\neq \sum$ per-hop perf
 - extra protocol needed (e.g. packet scheduling)

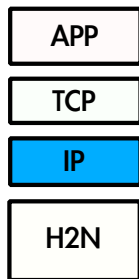

QoS at Layer 3: DiffServ protocol

DiffServ principle → traffic classification.

Classification (and Per-Hop Behavior (PHB)) using the 6-bit DSCP of IP packet field (ToS is deprecated).

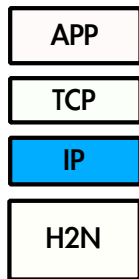
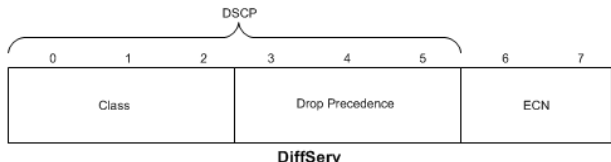
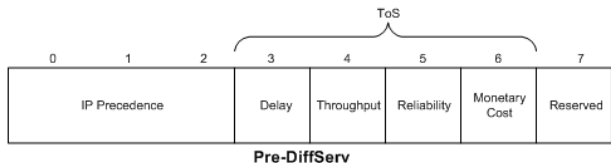

QoS at Layer 3: DiffServ protocol

Theoretically 64 different class of service (i.e. 2^6).
Intra-class division also possible, using src/dst address and service type.

Standard Per-Hop Behavior:

- Default PHB: best-effort traffic
- Expedited Forwarding (EF) PHB: low-loss, low-latency traffic
- Assured Forwarding (AF) PHB: assurance of delivery
- Class Selector PHBs: gives backward compatibility with the IP Precedence field.

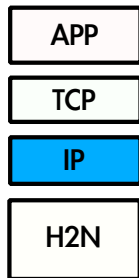

Merging Layer 2 and Layer 3 QoS

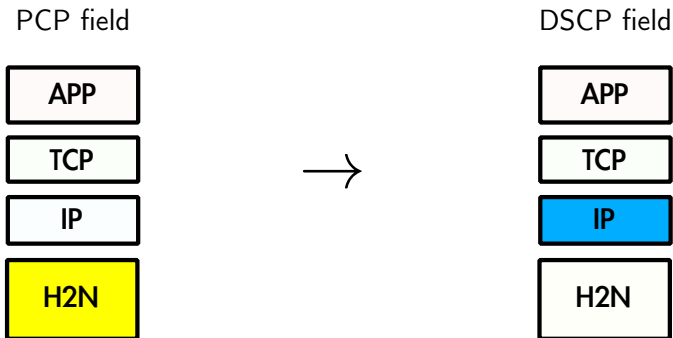

Merging Layer 2 and Layer 3 QoS

Cisco Router family RV180 / RV180W



Automatic mapping between 802.1p PCP class of service and the equivalent DSCP packet field one

Merging Layer 2 and Layer 3 QoS

Standard mapping between PCP and DSCP

Lv2 PCP	Lv3		Application
	DSCP	PHB	
0	0	0	Best Effort
1	8	CS1	Torrent
1	10	AF11	Bulk Data
2	16	CS2	Network Management
2	18	AF21	Transactional Data
3	24	CS3	Call Signaling
3	26	AF31	Mission-Critical Data
4	32	CS4	Streaming Video
4	34	AF41	Video Conferencing
5	46	EF	Voice
6	48	CS6	Routing
7	56	CS7	Network Control

just an example, DSCP could refine the classification (more and more)

QoS at Layer 4

Transport layer is a neglected area concerning QoS.
Two main protocols:

- TCP
 - Congestion Control
 - Fairness among flows
 - Friendliness among TCP algos
- UDP
 - NO Congestion Control
 - Problems delegated to level 3

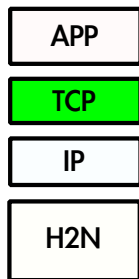

QoS at Layer 4: TCP

Not created for QoS but QoS could be evaluated:

- Congestion Control
 - Aggressive vs Careful
 - Avoid Congestion means avoid lot of QoS problems
- Fairness among flows
 - Flows of the same type should have the same bw
 - Flows of the same type with different RTTs?
- Friendliness among TCP algos
 - Fairness between flows of different TCP algos

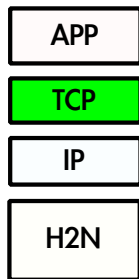

QoS at Layer 4: UDP

Not created for QoS and QoS is difficult to evaluate:

- NO Congestion Control
 - Agressive!
- Problems delegated to level 3
 - QoS is completely delegated to bottom layers
- DCCP
 - UDP + Congestion Control
 - At least avoid congestion to help bottom layers in QoS provisioning

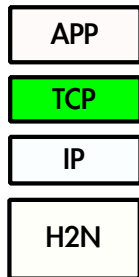

QoS at Layer 5

At the application layer the formal view of QoS is hard to achieve ...

... and QoS became ...

... Quality of Experience (QoE).

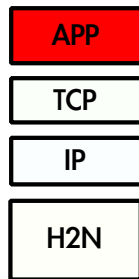

QoS at Layer 5: QoE

If QoS is complicated to define, QoE is worse:

- measure of a customer's experience with a service
 - completely subjective
 - NOT formal
- related to but differs from QoS
 - is the human QoS
- multidisciplinary
 - social psychology
 - cognitive science
 - economics
 - engineering science

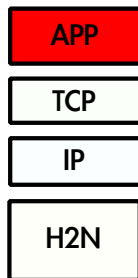

Quality of Service in IP networks

Why we need buffers?

- Sender side
 - save bursts of data to be send
 - wait for ACK (TCP)
- Receiver side
 - save bursts of data received
 - reordering problem
 - playback buffer (Audio/Video)
- Nodes on the path
 - store & forward technique
 - congestion management

Learn through an example

Host 2 wants to play an internet video stored in Host 1

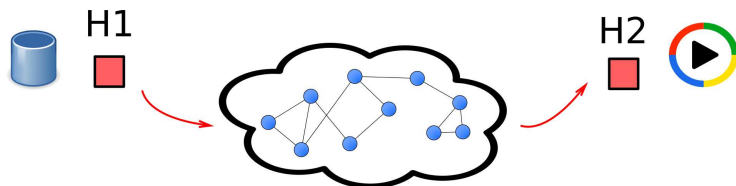

Delay Performance at the Receiver

Stored video to play has particular performance bound (see table at slide 5)

- Delay bound: video should start before a few seconds buffering
- Jitter bound: no delay variation between frames!

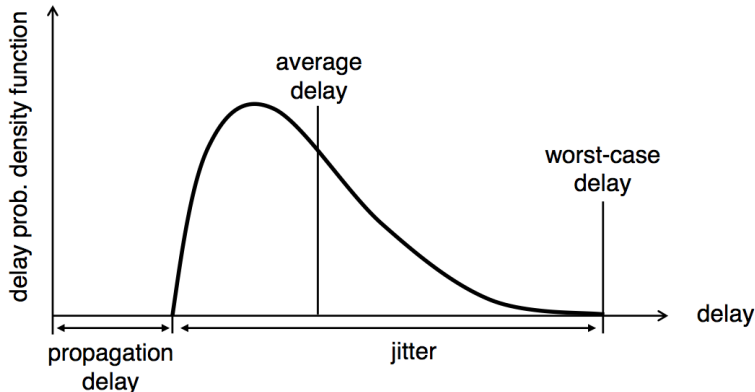

Delay Performance at the Receiver

The receiver buffer can compensate the delay variation (jitter) by:

- delaying the first packet in an elasticity buffer
- playing back packets at a constant rate from the buffer (emulate the sender)

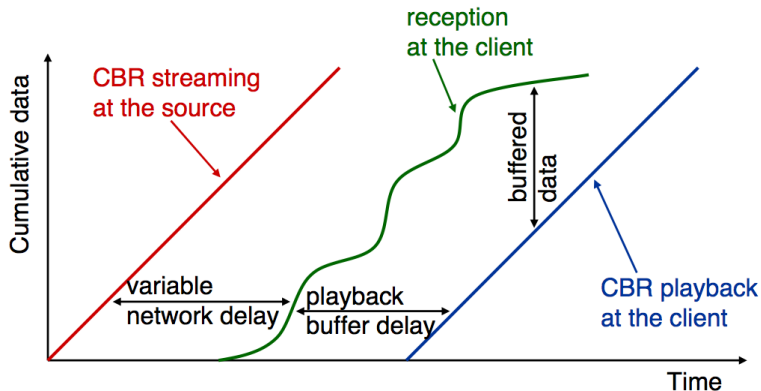

Delay Performance at the Receiver

Tuning the receiver buffer size:

- if too short, it will cause losses (frame losses)
- if too large, it will affect interactivity



Network Performance

Receiver buffer recap:

- helps in “playback” stored multimedia contents
- should be properly dimensioned
- mask delay/jitter issue for NON real time application

In case of real-time application the receiver buffer is not enough, in a network we find:

- buffers in intermediates nodes
- scheduling disciplines to choose next packet to transmit
 - fairly share the resources
 - provide performance guarantees

Packet Scheduling: a first look

Purpose:

- choose next packet to send on link

Constraints for a packet scheduler:

- not too expensive in terms of required hardware
- fast!!
- scalable (independent from the connections number)
- fair (fairly share the link capacity)
- protective (malicious flows do not affect other flows' performance)

QoS in IP network: Packet Scheduling

Learn through an example²

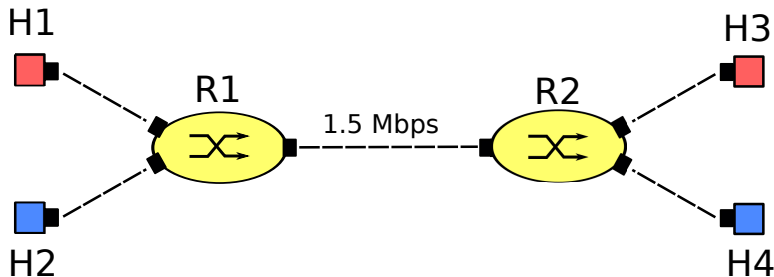

²Easy to deploy with ns3

QoS in IP network: Packet Scheduling

Our case-study example: 1Mbps IP phone and FTP share 1.5 Mbps link.

- only VoIP no problem ... (example of playback buffer)
- FTP could congest the network and cause:
 - delay increment
 - delay variation (jitter)
 - both problems for VoIP!!

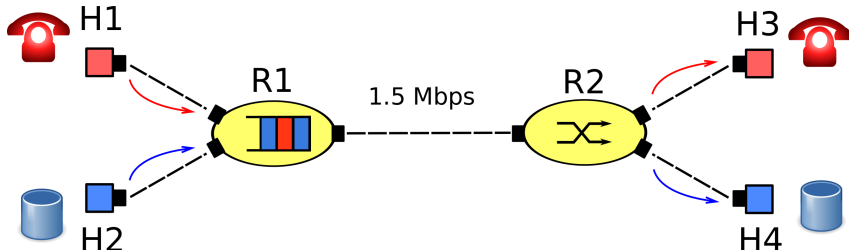

QoS in IP network: Packet Scheduling, Principle 1

Principle 1

we need to distinguish among packets belonging to different classes of traffic (VoIP vs FTP in the example), so, we need:

- a packet marker
- a router policy to treat packets accordingly (**packet scheduler**)

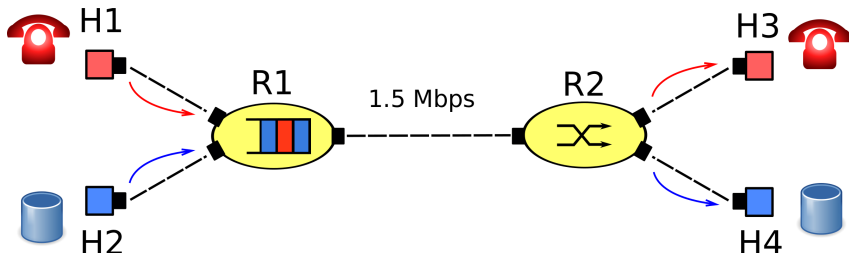

in the figure, FIFO is not enough :)

QoS in IP network: Packet Scheduling, Principle 2

Principle 2

provide protection (*isolation*) for one class from others, for example if:

- VoIP sends higher than declared rate
- FTP sends more until to congest the network!

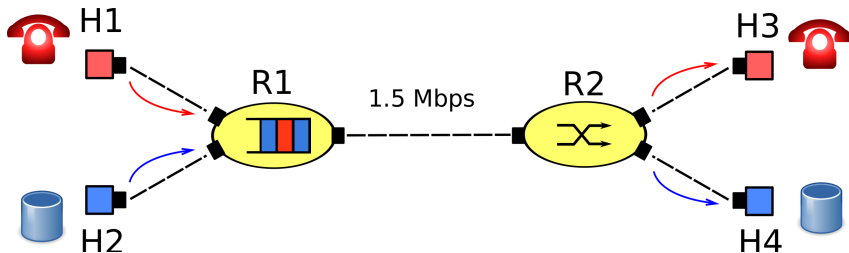

in the figure, FIFO is not enough :)

QoS in IP network: Packet Scheduling, Principle 3

Principle 3

While providing isolation among flows, it is desirable to use resources as efficiently as possible, example:

- link at 1.5 Mbps
- VoIP at 1 Mbps
- FTP with ≤ 0.5 Mbps is not efficient!

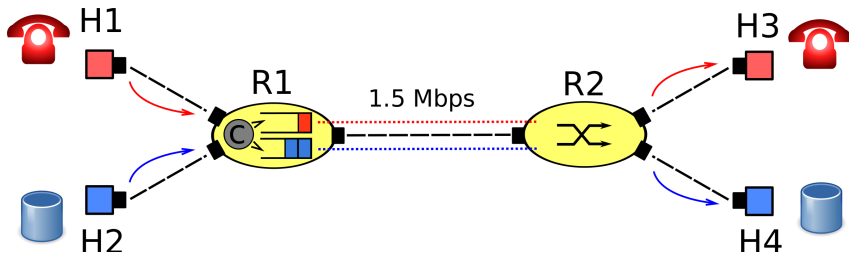

Packet Scheduling

And now?

How to choose the scheduling algorithm?

How many packet schedulers exist?

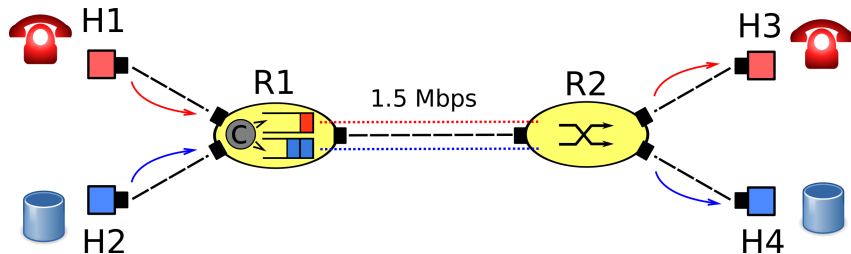

Packet Scheduling: Theory

- main requirement is fairness
- achievable using Generalized processor sharing (GPS)
 - visit each non-empty queue in turn
 - serve infinitesimal from each
 - fair like the fluid system problem

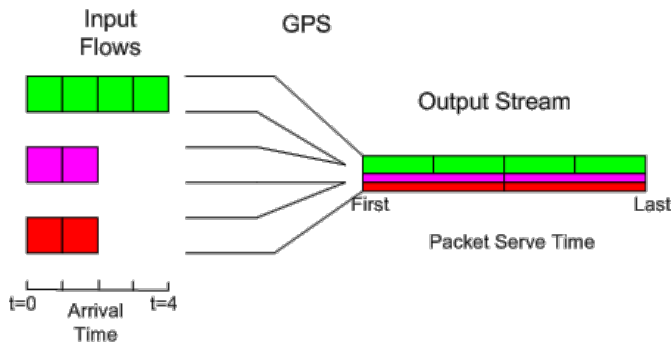

Packet Scheduling: Theory

- GPS is unimplementable! :(
 - we cannot serve infinitesimals, only packets
- **FACT:** NO packet discipline can be as fair as GPS
 - while a packet is being served, we are unfair to others

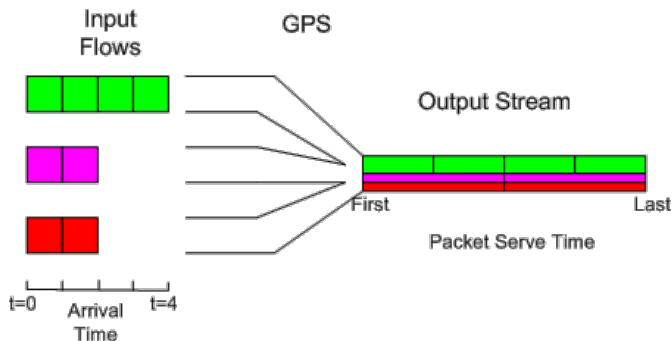

Packet Scheduling: Theory

- Degree of unfairness can be bounded

Definition: $W_i(t_1, t_2)$

number of bits transmitted by flow i in $[t_1, t_2]$ interval

- absolute fairness bound for scheduler S :

$$\max_i \{ W_i^{GPS}(t_1, t_2) - W_i^S(t_1, t_2) \} \quad \forall [t_1, t_2]$$

- relative fairness bound for scheduler S :

$$\max_{i,j} \{ W_i^S(t_1, t_2) - W_j^S(t_1, t_2) \} \quad \forall [t_1, t_2]$$

with i and j of the same weight, otherwise, normalize it

Type 1: FIFO

FIFO

First In First Out scheduling: send in order of arrival to queue

Pros:

- fast, $O(1)$ time complexity

Cons:

- no packet distinction (Principle 1)
- no insulation between different services (Principle 2)
- unfair: Flows of larger packets get better service

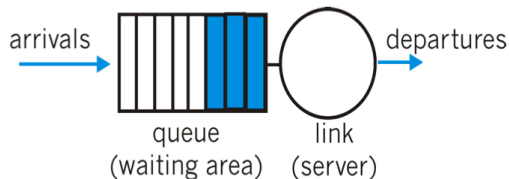

Type 2: PRIO

PRIO

Priority scheduling: Multiple priority classes, each has its own queue

Pros:

- mark packets, multiple queue (Principle 1), based on src/dst IP or port or DSCP field
- insolation for high priority flow (Principle 2)

Cons:

- insolation/starvation for low priority flows (Principle 2)
- priority management is $O(1) \dots O(\log n) \dots O(n)$

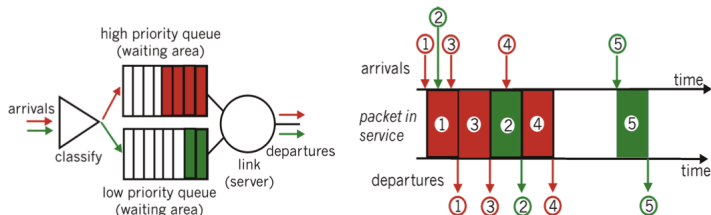

Type 3: RR

RR

Round Robin scheduling: cyclically scan class queues, serving one packet from each class (if available)

Pros:

- fast, $O(1)$ time complexity
- mark packets, multiple queue (Principle 1)
- no greedy advantage (Principle 2), work-conserving (Principle 3)

It looks like THE solution! ... but ... Cons:

- unfair, $O(n)$ deviation from optimal service
- works bad with different packet sizes

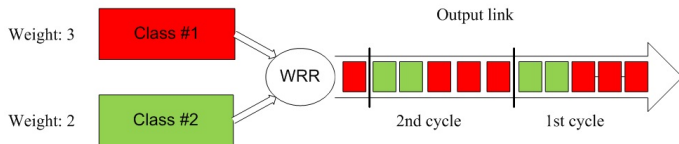

Type 4: Timestamp based Schedulers

Timestamp based Schedulers

Timestamp based schedulers emulate a fluid scheduler, the GPS one, as follows:

- compute, at each time, how much service the flow would receive in the Fluid system (*Virtual Time*)
- mark packet with their **Start** and **Finish** time in the fluid system
- schedule packets according to their **Finish** times
- to reduce burstiness, do not consider packets that have not started yet in the fluid system

Type 4.1: WFQ

Weighted Fair Queueing Scheduler

Timestamp based schedulers emulate a fluid scheduler, the GPS one, as follows:

- each flow i is given a weight w_i
- service rate received by flow i is:

$$r_i = \frac{R \cdot w_i}{w_1 + w_2 + \dots + w_n}$$

where R is the link rate

Type 4.1: WFQ

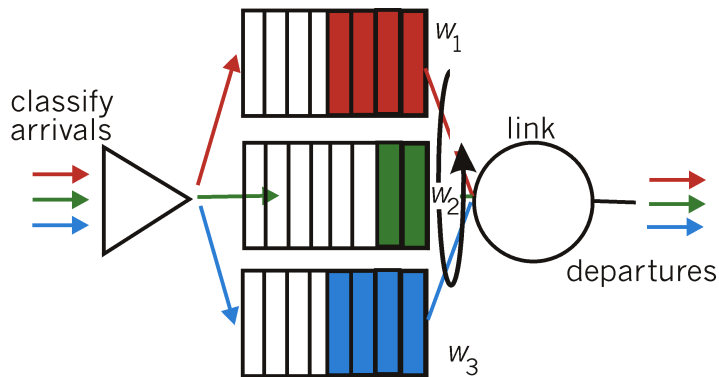

Type 4.1: WFQ

Pros:

- looks fair: departure time of a WFQ packet is always \leq of the departure time of GPS *fluid* packet plus a maximum packet service time
- gives Principle 1, 2 and 3

Cons:

- $\Omega(\log n)$ time complexity, due to timestamps (and keep it sorted)
- not good for Jitter bound

An $\Omega(\log n)$ time complexity looks, at a first glance, not too much! In our examples just 1, 2 or 3 flows are considered. Backbone routers manage several K flows!!!

Type 4.2: WF²Q

Worst-case Fair Weighted Fair Queueing Scheduler

Optimal service-guarantees variant of WFQ

- departure time of a WFQ packet is always \leq of the departure time of GPS *fluid* packet plus a maximum packet service time

$$t_{WFQ}^{start}(pkt_i) \leq t_{GPS}^{start}(pkt_i) + t_{max} \quad \forall i$$

- but WFQ might be well *ahead* of GPS!

Type 4.2: WFQ vs WF²Q

Learn through an example:

- 11 flows/services $S_1 \dots S_{11}$
- S_1 has 0.5 of the link rate R
- $S_2 = S_3 = \dots = S_{11}$ have 0.05 of R
- packet length of 1 second
(space length / R is 1 second)

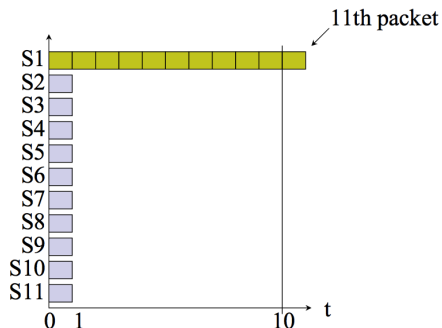

Type 4.2: WFQ vs WF²Q

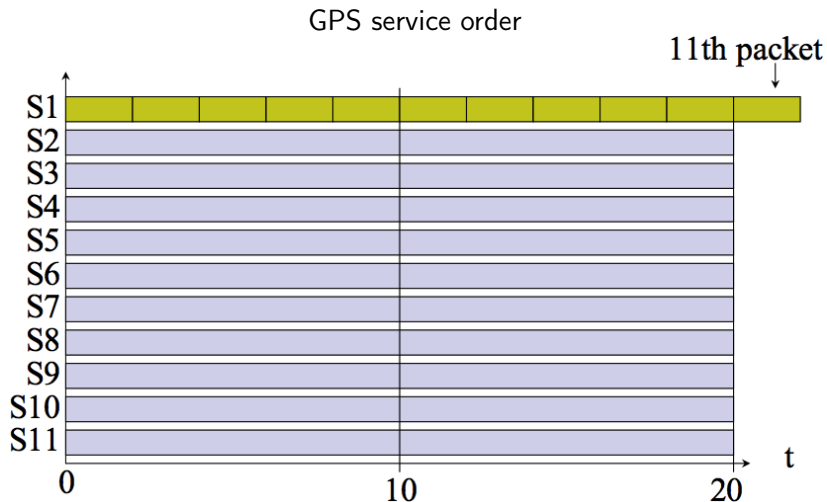

Type 4.2: WFQ vs WF²Q



Type 4.2: WFQ vs WF²Q



Type 4.2: WF²Q

Pros:

- **optimal** service B-WFI (bit Worst-Case Fair Index) of 1MSS def. as:

$$\max_{i, \Delta t} \{ \phi_i \cdot W(\Delta t) - W_i(\Delta t) \}$$

- gives Principle 1, 2 and 3

Cons:

- $\Omega(\log n)$ time complexity

Resources

- HFS details on my page:
http://www.dii.unimo.it/wiki/index.php/Carlo_Augusto_Grazia
- Networks Simulation lesson and ns3 <http://www.dii.unimo.it/wiki/images/b/ba/LessonNetworksSimulation.pdf>
- “GoogleTechTalks qfq”: <http://info.iet.unipi.it/~luigi/qfq/>
- P. Valente, “Providing Near-Optimal Fair-Queueing Guarantees at Round-Robin Amortized Cost”
<http://algo.ing.unimo.it/people/paolo/agg-sched/agg-sched.pdf>
- GPS problem:
http://en.wikipedia.org/wiki/Generalized_processor_sharing
- WFQ : http://en.wikipedia.org/wiki/Weighted_fair_queueing



carloaugusto.grazia@unimore.it